

HERZ-TS-FV

Ultra-high precision control valve
with indicating pre-setting

Standard Sheet for
7523 FV/7524 FV
Edition 1000 (0700)

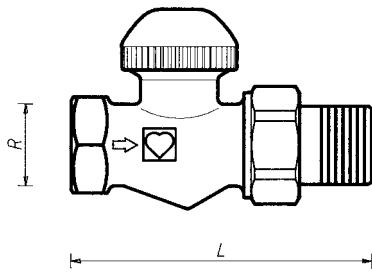

7523 FV

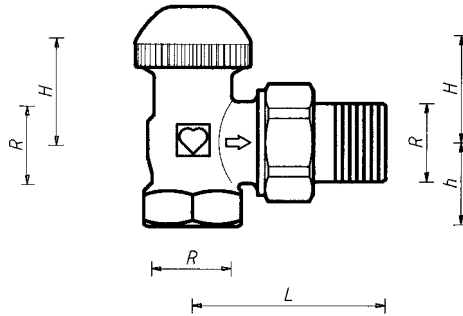

7524 FV

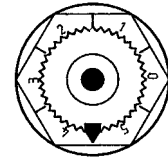

HERZ-TS-FV
Thermostatic Upper Part

Order No.	Model	DN	R	Ø	L	H	h	Series	Dimensions in mm
1 7523 68	Straight valve	15	1/2"	15	95	27	—	Dimensional Series "D"	 EN 215
1 7524 68	Angle valve	15	1/2"	15	58	23	26		
1 7523 67	Straight valve	15	1/2"	15	83	27	—	Dimensional Series "F"	
1 7524 67	Angle valve	15	1/2"	15	54	23	23		

All models are nickel-plated with purple screw cap.

Universal models with special socket for threaded pipes and pipe connections suitable for compression union.

Models

Max. operating temperature 120 °C
Max. operating pressure 10 bar

Hot water quality conforming to ÖNORM H 5195 and/or VDI guideline 2035.

When using HERZ compression unions for copper and steel pipes, observe the permissible temperatures and pressures as specified in EN 1254-2:1998 Table 5. A maximum operating temperature of 80 °C and maximum operating

Operating Data

HERZ Compression Unions

Clean heating water is required to prevent the limiter bores from clogging up. The customer should provide fine filters and/or floating particle separators.

Installation Instructions

Water heating systems with large temperature range.

Field of Application

Iron pipe connection 6210 with fitted cone seal
We recommend use of the HERZ assembly key 6680.

Pipe Connection

We reserve the right to make modifications in accordance with technological progress.

HERZ Armaturen

Richard-Strauss-Straße 22 • A-1230 Wien



Can be used instead of the radiator connection and on the male thread G 3/4:

6210	1/2"	Iron pipe connection, lengths 26 or 35 mm
6211	1/2"	Reducing connection, 1/2" x 3/8"
6218	1/2"	Long threaded bush, without nut, can be shortened to compensate for differences in structural dimensions, lengths 39, 42 and 76 mm
6218	1/2"	Threaded bush, without nut, lengths 36, 48 and 76 mm
6235	1/2"	Soldering connection, 12, 15 and 18 mm
6249	1/2"	Iron pipe connection elbow, without nut, with cone seal
6274	G 3/4	Compression union for copper and thin-walled steel pipes, for external pipe diameters 8, 10, 12, 14, 15, 16 and 18 mm
6275	G 3/4	Compression union with soft seal for copper and thin-walled steel pipes, particularly suitable for hard special steel pipes and pipes with hard galvanised surfaces. For external pipe diameters 12, 14 and 15 mm
6098	G 3/4	Compression union for PE-X-, PB and plastic composite pipes.

For use on the socket side of the valve:

6219	1/2"	Reducing connection, brass, for connecting pipe and valve, female thread (pipe) x male thread (valve) 1" x 1/2", 1 1/4" x 1/2".
6066	M 22 x 1,5	Plastic pipe connection for PE-X-, PB and plastic composite pipes, for use with adapter 1 6272 01 (R 1/2 x M 22 x 1,5).
6098	G 3/4	Plastic pipe connection for PE-X, PB and plastic composite pipes, for use with adapter 1 6266 01 (R 1/2 x G 3/4).

For pipe dimensions of plastic pipe connections refer to the HERZ catalogue.

Further Connecting Options

For order numbers see HERZ catalogue.

Universal models are fitted with special sockets offering the option of connecting either a threaded pipe or a calibrated soft steel or copper pipe, the latter two by means of a compression union. The compression union must be ordered separately.

When using valves for external pipe diameters of 10, 12, 14, 16 and 18 mm use adapter Article No. 6272 between the valve and the compression union.

Pipe Ø D mm		10	12	14	15	16	18
Valve	R =	1/2"					
Adapter	Order No.	1 6272 01	1 6272 01	1 6272 01		1 6272 01	1 6272 11
Compression Union	Order No.	1 6284 00	1 6284 01	1 6284 03	1 6292 01	1 6284 05	1 6289 01

We recommend use of support sleeves for the installation of soft steel or copper pipes with compression unions. For perfect installation, it is imperative to lubricate the thread of the locking nut (male thread and female thread) as well as the olive itself with silicon oil. We refer to our instructions for installation.

Pipe Connection Universal Models

Pre-setting is performed by means of a flow restrictor downstream of the valve seat enclosing the valve seal. This flow restrictor is adjustable from the outside. It does not obstruct the working lift of the valve spindle.

Pre-setting can be performed manually by means of the purple pre-setting button. This is performed by setting the pointer on the pre-setting button to the figure on the scale of the upper part obtained by calculation or from the HERZ standard diagram.

For convenient pre-setting a HERZ pre-setting key is available (1 **6819** 98) which engages with the teeth of the pre-setting button.

Pre-Setting Function

The upper part can be replaced easily while the system is in operation using the HERZ changing tool. Follow the enclosed operating instructions during use.

Order number for HERZ changing tool: 1 **7780** 00.

Changing the Thermostatic Valve Upper Parts

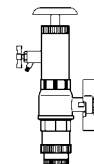

1. Remove HERZ thermostatic head, handwheel or screw cap.
 2. Set purple pre-setting button (manufacturer's setting step "6") manually or with the pre-setting key (1 **6819** 98) to the desired pre-setting step 1–6.
 3. Mount HERZ thermostatic head or handwheel.
- The valve setting has now been locked.

Setting Instructions



Pre-Setting Key 1 6819 98

The spindle seal is a special sealing ring which keeps maintenance requirements to a minimum and ensures ease of valve operation over a long period of time. If the spindle seal is worn, the upper valve part is replaced, which means simultaneous replacement of the seat seal which may also be damaged.

The pre-setting stage is to be reset after changing the upper part.

1. Remove the HERZ thermostatic head or HERZ-TS-handwheel.
2. Unscrew the old upper part and replace it with a new one.
3. Replace the HERZ thermostatic head or the HERZ-TS handwheel.

The upper part can be changed while the system is still under pressure using the HERZ changing tool. Follow the operating instructions for the HERZ changing tool.

Order number for HERZ-TS-FV-valve upper part: 1 **6367 99**.

Spindle Seal



HERZ-TS-FV-Upper Part

The screw cap serves for operation during the installation phase (pipe flushing). The thermostatic valve is formed by removing the screw cap and screwing in the HERZ thermostatic head without draining the heating system.

Setting the nominal lift with the screw cap:

On the knurled part of the circumference of the screw cap there are two setting marks (webs) in alignment with the "+" and "-" marks.

1. Close the valve by turning the screw cap clockwise.
2. Mark the position corresponding to the setting mark "+".
3. Turn the screw cap anti-clockwise until the setting mark "-" is at the position marked under item 2.

HERZ Thermostatic Valve

Nominal Lift



In the exceptional case that the HERZ thermostatic valve is not equipped with a HERZ thermostatic head, the HERZ-TS handwheel is used to replace the screw cap.

During installation, follow the instructions enclosed with the handwheel.

HERZ-TS Handwheel



The lower part of the thermostatic valve is incorporated into the radiator intake with the flow in the direction of the arrow (arrow on the valve body). If possible, the HERZ thermostatic head should be in a horizontal position in order to permit optimum room temperature control and minimise interference.

Installation

Under no circumstances should the HERZ thermostatic head be exposed to direct sunlight or equipment that emits relevant quantities of heat – e.g. television sets. If the radiator is covered (e.g. by curtains), this will cause heat accumulation zones in which the thermostat cannot sense the room temperature and cannot therefore control it. In these cases, use HERZ thermostats with remote sensor or remote control.

For details on HERZ thermostats refer to the respective product standard sheets.

Important for Installation

After the end of the heating period open the valve completely by turning it in an anti-clockwise direction to prevent dirt deposits at the valve seat.

Summer Setting

Pre-setting step	k _v -value
1	0.019
2	0.043
3	0.089
4	0.17
5	0.26
6	0.3
max. (k _v s)	0.39

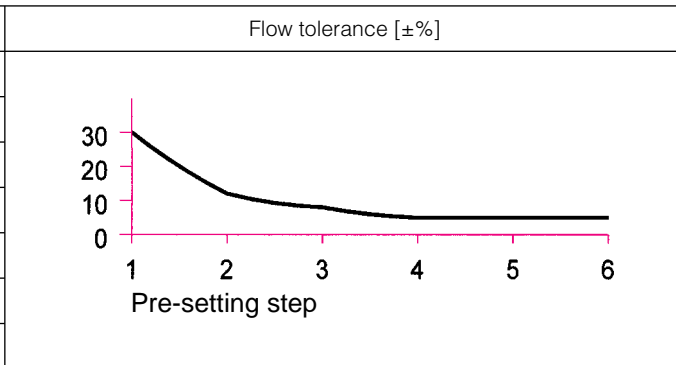

**k_v-Values
Standard flow tolerance**

- 1 **6680 00** HERZ Assembly key for connections
- 1 **6807 90** HERZ-TS-90 Assembly key
- 1 **6819 98** HERZ Setting key
- 1 **7780 00** HERZ Changing tool, changing tool for thermostat upper parts
- 1 **7102 80** HERZ-TS-90 Handwheel, 7000 Series with pre-setting and locking function.
- 1 **9102 80** HERZ-TS-FV Handwheel, 9000 Series "Design"

Accessories

Handwheels

- 1 **6367 99** HERZ-TS-FV thermostat upper part

Spare Parts

HERZ Standard Diagram

HERZ-TS-FV

Art. No. 7523 FV/7524 FV

Dim. DN 15 R = 1/2"

Valve dimensioning (Δp) must be performed in accordance with the "VDMA-Instruction Sheet for Planning and Hydraulic Balancing of Heating Systems with Thermostatic Radiator Valves."

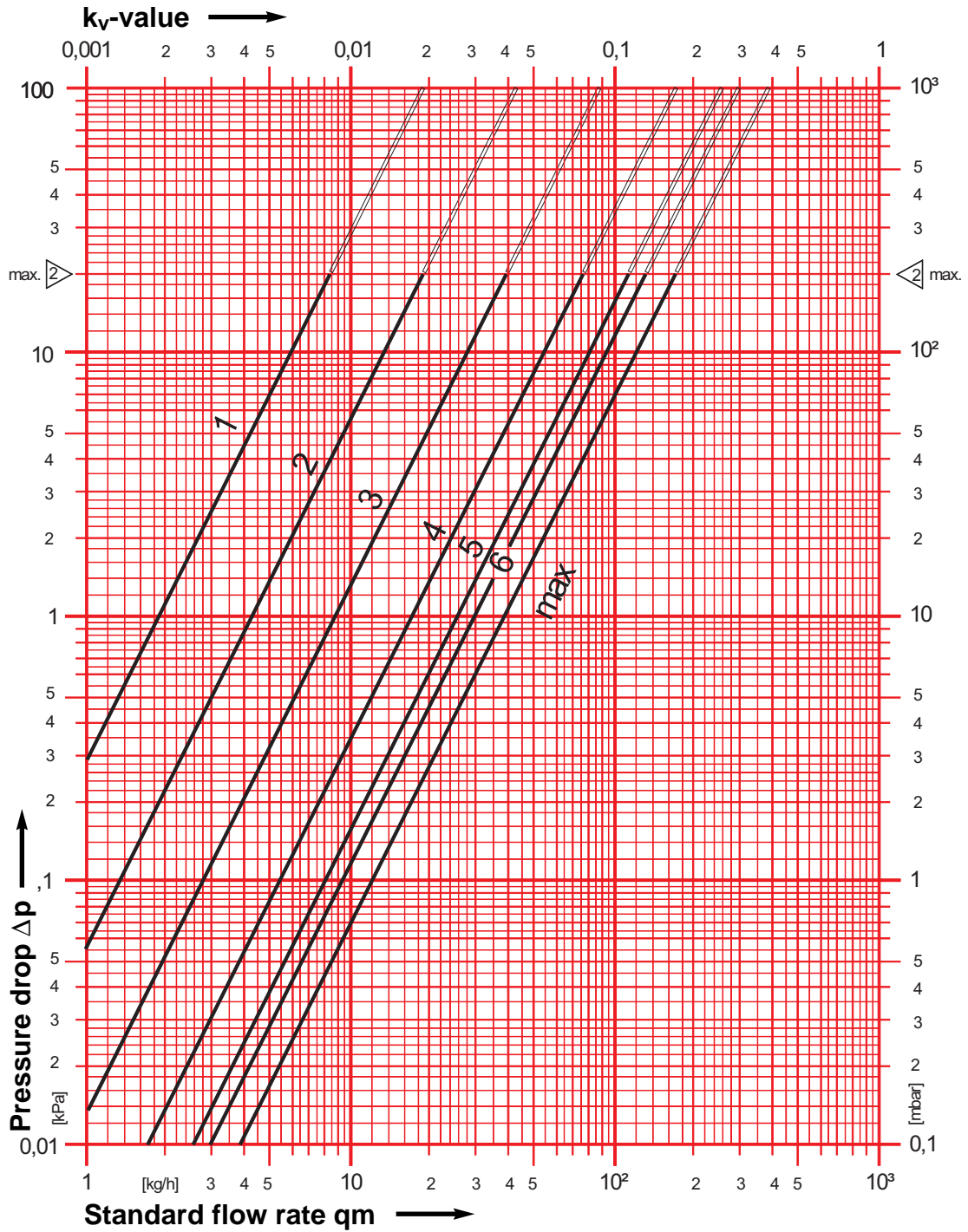

We reserve the right to make modifications.

HERZ Armaturen

Richard-Strauss-Straße 22 • A-1230 Wien

