

# SERIES GRC

Circular Diffusers

PUBLICATION

DIFFUSERS 3

JUNE 2012

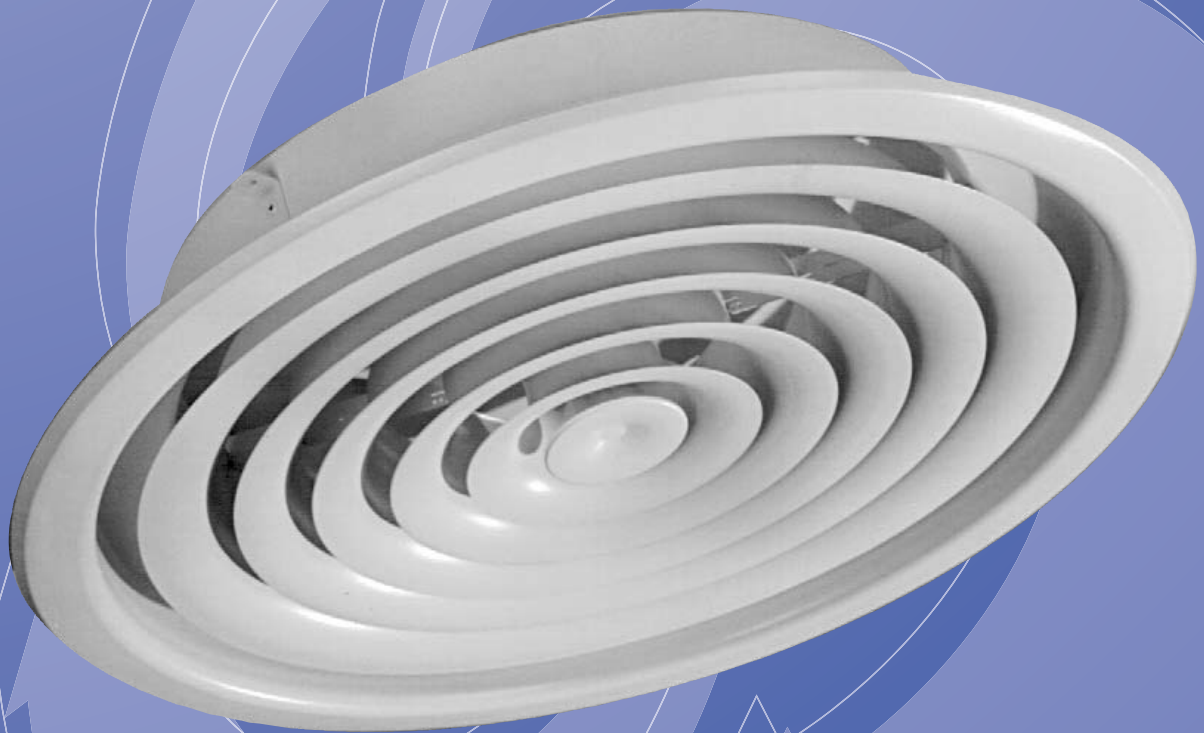

## Features

- Modern Design and Styling.
- Omni Directional Discharge.
- Horizontal and Vertical Projection.
- Efficient and Effective High Capacity Distribution.
- Two Position Removable Core.
- Aluminium Construction.



**GILBERTS**

# SERIES GRC

## Circular Diffusers

### Introduction

Gilberts Series GRC Circular Diffusers provide an alternative to conventional square and rectangular diffusers for both ceiling supply and ceiling extract applications. Mounted on exposed Ductwork or flush with a conventional ceiling and offering an attractive appearance these omnidirectional diffusers, with their aerodynamic profile, are capable of handling high air volumes at comparatively low sound levels and give a smooth even distribution of air.

To allow for horizontal or vertical protection the central core has two set positions using a bayonet type fixing. To install, the core is simply offered up into the outer frame and rotated until it reaches its stop point and can then be lowered onto its securing brackets. In reverse, pushing the core up and turning it then releases it for removal, allowing for simple fixing, balancing, cleaning or damper adjustment.



### Features

- Modern Design and Styling.
- Omni Directional Discharge.
- Horizontal and Vertical Projection.
- Efficient and Effective High Capacity Distribution.
- Two Position Removable Core.
- Aluminium Construction.

### Performance Data

The performance tables that are illustrated in this brochure give tabulated data for each listed size of diffuser. The figures given relate to Cooling, Ventilation and heating applications and are given for both horizontal and vertical distribution of conditioned air.

#### References used

Pressure: All pressures are in Pa (N/m<sup>2</sup> static pressure)

### Selection Procedure

Having established the position where terminals can be sited measure the acceptable throw distances. It is better to try and position circular diffusers in the centre of an imaginary square ceiling grid so that distribution is even in all directions. Knowing the volume and throw for each diffuser in question then check:

- (a) Size as selected to give throw of air required lying between maximum and minimum values;
- (b) Note sound level from performance data and check this with recommended sound levels;
- (c) Determine the static pressure drop from performance data.

Gilberts Supply Diffusers have been tested within the range of +/- 10°C (as recommended in the HEVAC Guide to Air Distribution Technology). For any other temperature differential requirements please contact our Technical Department.

Volume control is available either via a compact rotary sliding plate damper fitted directly on the diffuser neck or a quadrant / cord operated flap damper or iris damper fitted to the plenum inlet. Standard top and side entry plenums are available to cater for alternative neck/inlet size requirements.

Available in 9 standard neck sizes ranging from 150 dia up to 650 dia the standard finish on the GRC Series is a Polyester Powder White. Other colours and finishes are available on request.

#### Horizontal Distribution

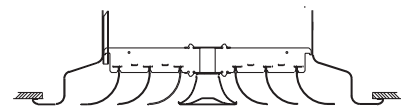

Core Down

#### Vertical Distribution

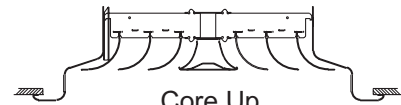

Core Up

**Throw:** Distances are given for both 0.5 and 0.25 m/s terminal velocities and are based upon a ceiling effect for horizontal distribution and free field for vertical distribution.

**Sound:** The NC values are peak values on the NC curves. For selection at lower noise levels than NC20 please consult with our technical department.

Area to be served	Recommended Maximum NC Levels
Sound Broadcasting	15 - 20
Recording Studios TV (Audience Studios)	20 - 25
Lecture Theatres, Cinemas, Concert Halls, Boardroom/Ex Offices Lounge, Conference Room, Court Room, Churches, Private Bedrooms	25 - 30
Operating Theatres, Hospital Wards, Staff Room, Class Rooms, Ballroom, Banquet Room, Library, Bank, Museum, Offices	30 - 40
Restaurants, Department Stores, Computer Suite, Washroom Toilet	35 - 40
Laundries, Kitchens, Swimming Pools, Sports Arena	40 - 45
Garage, Light Engineering Workshop	45 - 50
Heavy Engineering Workshop	50 - 65

# Series GRC

Size 150, 250, 350,  
450, 550, 650.

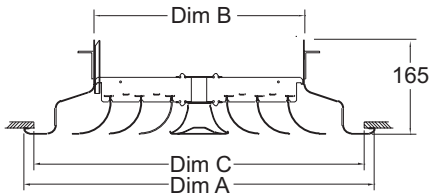

GRC			
SIZE	A	B	C
150	375	145	342
250	475	245	442
350	575	345	545
450	675	445	642
550	775	545	742
650	875	645	842

Size 315, 500, 630.

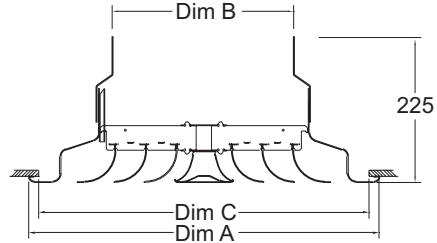

GRC			
SIZE	A	B	C
315	575	310	545
500	775	495	742
630	875	625	842

Above sizes fitted with neck reducer

Diffuser c/w  
Side Entry Box

Length to suit  
Damper Dia.  
(where fitted)

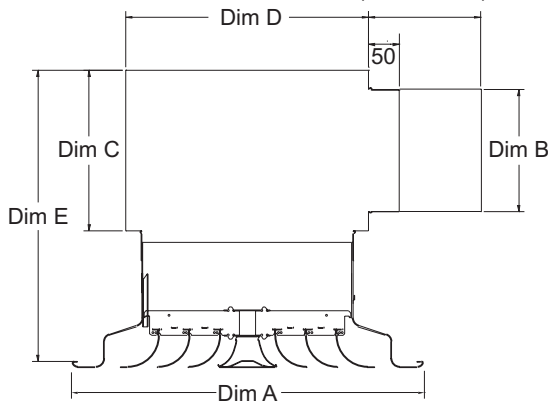

GRC - SEB					
SIZE	A	B	C	D	E
150	375	125	177	250	362
250	475	200	252	350	437
350	575	300	352	450	537
450	675	400	452	550	637
550	775	450	502	650	687
650	875	500	552	750	737

Diffuser c/w  
Top Entry Box

Length to suit  
Damper Dia.  
(where fitted)

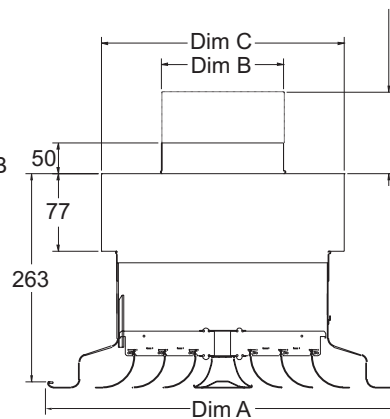

GRC - TCB			
SIZE	A	B	C
150	375	125	250
250	475	200	350
350	575	300	450
450	675	400	550
550	775	450	650
650	875	500	750

# Volume Control

Exterior Handle Operation

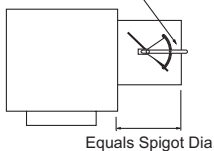

Quadrant... Ref DQ

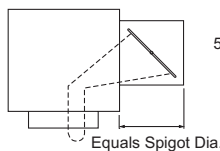

Cord... Ref DC

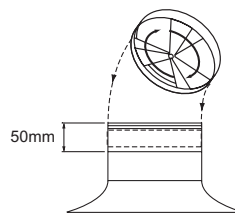

Rotary... Ref DR

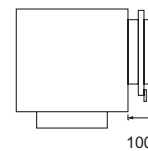

Iris... Ref DI



# Technical Performance Data

## HORIZONTAL DISTRIBUTION

### SIZE 150

Volume Flow rate m <sup>3</sup> /s	0.04	0.05	0.06	0.07	0.08	0.09	
Pressure Drop (Pa)	Top Entry	3.4	5.3	7.4	10.0	13.0	17.0
Throw to 0.25m/s (m)	Δt +10°C	1.6	1.9	2.3	2.6	2.7	2.9
	Δt +5°C	1.5	1.8	2.1	2.5	2.6	2.8
	Isothermal	1.4	1.6	2.0	2.4	2.6	2.8
	Δt -5°C	1.1	1.3	1.7	2.1	2.4	2.7
	Δt -10°C	0.9	1.0	1.4	1.9	2.2	2.6
Throw to 0.5m/s (m)	Δt +10°C	0.2	0.5	0.6	0.9	1.2	1.5
	Δt +5°C	0.2	0.4	0.5	0.7	1.1	1.4
	Isothermal	0.2	0.4	0.5	0.6	1.0	1.3
	Δt -5°C	0.2	0.3	0.4	0.5	0.9	1.3
	Δt -10°C	0.2	0.3	0.4	0.5	0.8	1.2
Noise Level NC	Top Entry	20	20	25	30	35	40

### SIZE 250

Volume Flow rate m <sup>3</sup> /s	0.05	0.09	0.13	0.17	0.21	0.25	
Pressure Drop (Pa)	Top Entry	1.2	3.6	7.5	13.0	20.0	28.0
Throw to 0.25m/s (m)	Δt +10°C	1.2	1.8	2.5	3.2	3.6	3.8
	Δt +5°C	1.2	1.8	2.4	3.1	3.5	3.7
	Isothermal	1.2	1.8	2.4	3.0	3.4	3.6
	Δt -5°C	1.2	1.7	2.3	2.9	3.2	3.3
	Δt -10°C	1.2	1.6	2.2	2.8	2.9	3.0
Throw to 0.5m/s (m)	Δt +10°C	0.4	0.6	1.2	1.8	2.3	2.8
	Δt +5°C	0.4	0.6	1.2	1.8	2.3	2.7
	Isothermal	0.4	0.6	1.2	1.8	2.2	2.6
	Δt -5°C	0.4	0.5	1.1	1.7	2.1	2.5
	Δt -10°C	0.4	0.4	1.0	1.6	2.0	2.4
Noise Level NC	Top Entry	15	15	15	25	30	40

### SIZE 315/350

Volume Flow rate m <sup>3</sup> /s	0.15	0.2	0.25	0.3	0.35	0.4	
Pressure Drop (Pa)	Top Entry	1.0	2.0	3.0	5.0	6.0	8.0
Throw to 0.25m/s (m)	Δt +10°C	2.4	2.7	3.0	3.7	4.5	5.2
	Δt +5°C	2.1	2.7	3.3	3.8	4.3	5.4
	Isothermal	1.8	2.6	3.6	3.9	4.2	5.3
	Δt -5°C	1.5	2.3	3.3	3.8	4.3	5.2
	Δt -10°C	1.2	2.1	3.0	3.7	4.5	5.3
Throw to 0.5m/s (m)	Δt +10°C	1.0	1.4	1.8	2.1	2.5	2.9
	Δt +5°C	0.8	1.3	1.9	2.2	2.5	2.8
	Isothermal	0.5	1.2	2.0	2.2	2.5	2.7
	Δt -5°C	0.8	1.3	1.9	2.2	2.5	2.7
	Δt -10°C	1.0	1.4	1.8	2.1	2.4	2.8
Noise Level NC	Top Entry	15	15	15	25	35	40

## VERTICAL DISTRIBUTION

### SIZE 150

Volume Flow rate m <sup>3</sup> /s	0.04	0.05	0.06	0.07	0.08	0.09	
Pressure Drop (Pa)	Top Entry	7.5	12.0	18.0	24.0	32.0	40.0
Throw to 0.25m/s (m)	Δt +10°C	2.1	2.7	3.3	3.6	4.0	4.5
	Δt +5°C	2.5	3.3	3.8	4.5	4.8	5.6
	Isothermal	3.0	3.9	4.8	5.4	6.0	6.8
	Δt -5°C	3.4	4.2	5.0	5.8	6.5	7.4
	Δt -10°C	3.9	4.6	5.4	6.2	7.0	8.0
Throw to 0.5m/s (m)	Δt +10°C	1.3	2.0	2.8	3.0	3.2	3.5
	Δt +5°C	1.6	2.2	3.1	3.4	3.7	4.1
	Isothermal	1.8	2.5	3.3	3.8	4.2	4.8
	Δt -5°C	2.2	3.1	3.6	4.4	5.0	5.7
	Δt -10°C	3.2	3.8	4.4	5.0	5.8	6.6
Noise Level NC	Top Entry	20	25	25	30	35	40

### SIZE 250

Volume Flow rate m <sup>3</sup> /s	0.05	0.09	0.13	0.17	0.21	0.25	
Pressure Drop (Pa)	Top Entry	3.7	10.8	22.0	37.4	52.0	74.0
Throw to 0.25m/s (m)	Δt +10°C	0.8	1.6	2.5	3.0	3.5	4.2
	Δt +5°C	1.9	3.2	4.3	4.6	5.0	5.6
	Isothermal	3.0	4.8	6.5	7.8	>8.0	>8.0
	Δt -5°C	4.0	6.5	>8.0	>8.0	>8.0	>8.0
	Δt -10°C	5.2	8.0	>8.0	>8.0	>8.0	>8.0
Throw to 0.5m/s (m)	Δt +10°C	0.8	0.9	2.0	2.5	3.2	3.9
	Δt +5°C	1.3	2.0	3.5	5.0	6.2	6.8
	Isothermal	2.5	3.0	5.5	8.0	>8.0	>8.0
	Δt -5°C	3.8	5.0	7.4	>8.0	>8.0	>8.0
	Δt -10°C	5.8	7.0	10.0	>8.0	>8.0	>8.0
Noise Level NC	Top Entry	15	15	25	35	40	45

### SIZE 315/350

Volume Flow rate m <sup>3</sup> /s	0.15	0.2	0.25	0.3	0.35	0.4	
Pressure Drop (Pa)	Top Entry	5.0	8.8	14.6	19.0	27.5	35.0
Throw to 0.25m/s (m)	Δt +10°C	2.0	2.2	2.8	3.3	3.8	4.3
	Δt +5°C	3.0	3.3	3.7	4.4	5.2	5.8
	Isothermal	5.2	6.6	7.8	>8.0	>8.0	>8.0
	Δt -5°C	7.5	8.0	>8.0	>8.0	>8.0	>8.0
	Δt -10°C	>8.0	>8.0	>8.0	>8.0	>8.0	>8.0
Throw to 0.5m/s (m)	Δt +10°C	1.7	2.1	2.5	3.0	3.5	4.0
	Δt +5°C	2.3	2.5	3.3	4.0	4.6	5.3
	Isothermal	4.6	5.0	6.4	7.5	>8.0	>8.0
	Δt -5°C	7.3	7.8	>8.0	>8.0	>8.0	>8.0
	Δt -10°C	7.8	8.0	>8.0	>8.0	>8.0	>8.0
Noise Level NC	Top Entry	15	20	25	30	40	45



# Technical Performance Data

## HORIZONTAL DISTRIBUTION

### SIZE 450

Volume Flow rate m <sup>3</sup> /s	0.25	0.3	0.35	0.4	0.45	0.5	
Pressure Drop (Pa)	Top Entry	3.8	5.0	7.0	8.4	10.0	13.5
Throw to 0.25m/s (m)	$\Delta t +10^{\circ}\text{C}$	3.8	4.6	5.5	6.3	7.0	8.0
	$\Delta t +5^{\circ}\text{C}$	3.7	4.4	5.7	6.0	6.5	7.4
	Isothermal	3.6	4.3	5.0	5.5	6.0	6.8
	$\Delta t -5^{\circ}\text{C}$	2.8	3.4	4.0	4.5	5.1	5.6
	$\Delta t -10^{\circ}\text{C}$	2.1	2.6	3.0	3.6	4.2	4.5
Throw to 0.5m/s (m)	$\Delta t +10^{\circ}\text{C}$	2.2	2.5	2.8	3.1	3.5	3.8
	$\Delta t +5^{\circ}\text{C}$	2.1	2.3	2.6	3.3	3.2	3.4
	Isothermal	2.0	2.2	2.5	2.6	2.8	3.0
	$\Delta t -5^{\circ}\text{C}$	1.9	2.1	2.4	2.5	2.6	2.9
	$\Delta t -10^{\circ}\text{C}$	1.8	2.0	2.3	2.4	2.5	2.8
Noise Level NC	Top Entry	15	20	25	30	35	35

### SIZE 500/550

Volume Flow rate m <sup>3</sup> /s	0.37	0.43	0.49	0.55	0.61	0.67	
Pressure Drop (Pa)	Top Entry	4.5	6.6	8.0	10.0	12.0	15.0
Throw to 0.25m/s (m)	$\Delta t +10^{\circ}\text{C}$	3.6	4.5	5.6	6.3	7.0	8.2
	$\Delta t +5^{\circ}\text{C}$	3.3	4.1	5.0	5.5	6.0	7.3
	Isothermal	3.0	3.8	4.5	4.8	5.0	6.5
	$\Delta t -5^{\circ}\text{C}$	2.9	3.6	4.2	4.5	4.9	6.3
	$\Delta t -10^{\circ}\text{C}$	2.8	3.0	4.0	4.3	4.8	6.0
Throw to 0.5m/s (m)	$\Delta t +10^{\circ}\text{C}$	2.1	2.5	2.9	3.5	4.6	5.5
	$\Delta t +5^{\circ}\text{C}$	1.9	2.4	2.7	3.3	4.3	5.0
	Isothermal	1.8	2.2	2.5	3.1	3.8	4.5
	$\Delta t -5^{\circ}\text{C}$	1.6	2.0	2.3	3.0	3.6	4.2
	$\Delta t -10^{\circ}\text{C}$	1.5	1.8	2.1	2.8	3.5	4.1
Noise Level NC	Top Entry	15	15	20	20	25	25

### SIZE 630/650

Volume Flow rate m <sup>3</sup> /s	0.50	0.64	0.78	0.92	1.06	1.20	
Pressure Drop (Pa)	Top Entry	5.1	8.4	11.7	18.0	24.0	31.0
Throw to 0.25m/s (m)	$\Delta t +10^{\circ}\text{C}$	4.2	5.1	6.0	7.2	8.5	10.0
	$\Delta t +5^{\circ}\text{C}$	3.8	4.6	5.5	6.4	7.3	8.5
	Isothermal	3.5	4.3	5.0	5.6	6.2	7.0
	$\Delta t -5^{\circ}\text{C}$	3.2	4.0	4.8	5.3	5.9	6.7
	$\Delta t -10^{\circ}\text{C}$	2.9	3.7	4.6	4.8	5.6	6.5
Throw to 0.5m/s (m)	$\Delta t +10^{\circ}\text{C}$	2.3	3.0	3.4	3.8	5.0	6.3
	$\Delta t +5^{\circ}\text{C}$	2.2	2.8	3.1	3.5	4.6	5.6
	Isothermal	2.0	2.5	2.8	3.3	4.2	5.0
	$\Delta t -5^{\circ}\text{C}$	1.9	2.3	2.7	3.2	3.9	4.6
	$\Delta t -10^{\circ}\text{C}$	1.8	2.1	2.5	3.0	3.6	4.4
Noise Level NC	Top Entry	20	20	25	35	40	50

## VERTICAL DISTRIBUTION

### SIZE 450

Volume Flow rate m <sup>3</sup> /s	0.25	0.3	0.35	0.4	0.45	0.5	
Pressure Drop (Pa)	Top Entry	9.0	13.0	18.0	24.0	30.0	40.0
Throw to 0.25m/s (m)	$\Delta t +10^{\circ}\text{C}$	2.5	3.3	4.2	5.0	6.0	7.2
	$\Delta t +5^{\circ}\text{C}$	4.0	4.8	6.3	7.8	>8.0	>8.0
	Isothermal	7.0	8.5	>8.0	>8.0	>8.0	>8.0
	$\Delta t -5^{\circ}\text{C}$	7.5	>8.0	>8.0	>8.0	>8.0	>8.0
	$\Delta t -10^{\circ}\text{C}$	>8.0	>8.0	>8.0	>8.0	>8.0	>8.0
Throw to 0.5m/s (m)	$\Delta t +10^{\circ}\text{C}$	1.7	2.1	2.5	2.9	3.3	3.6
	$\Delta t +5^{\circ}\text{C}$	2.3	2.9	3.4	4.0	4.3	4.8
	Isothermal	5.7	7.0	7.3	7.6	7.9	>8.0
	$\Delta t -5^{\circ}\text{C}$	7.6	7.9	>8.0	>8.0	>8.0	>8.0
	$\Delta t -10^{\circ}\text{C}$	>8.0	>8.0	>8.0	>8.0	>8.0	>8.0
Noise Level NC	Top Entry	20	25	35	35	40	45

### SIZE 500/550

Volume Flow rate m <sup>3</sup> /s	0.37	0.43	0.49	0.55	0.61	0.67	
Pressure Drop (Pa)	Top Entry	10.0	14.0	17.0	23.0	29.0	34.0
Throw to 0.25m/s (m)	$\Delta t +10^{\circ}\text{C}$	2.2	2.7	3.1	3.5	3.8	4.1
	$\Delta t +5^{\circ}\text{C}$	3.1	3.5	4.0	4.5	5.1	5.5
	Isothermal	>8.0	>8.0	>8.0	>8.0	>8.0	>8.0
	$\Delta t -5^{\circ}\text{C}$	>8.0	>8.0	>8.0	>8.0	>8.0	>8.0
	$\Delta t -10^{\circ}\text{C}$	>8.0	>8.0	>8.0	>8.0	>8.0	>8.0
Throw to 0.5m/s (m)	$\Delta t +10^{\circ}\text{C}$	1.9	2.3	2.7	3.1	3.4	3.7
	$\Delta t +5^{\circ}\text{C}$	2.7	3.2	3.7	4.1	4.6	5.0
	Isothermal	7.1	7.4	7.6	7.9	>8.0	>8.0
	$\Delta t -5^{\circ}\text{C}$	8.0	>8.0	>8.0	>8.0	>8.0	>8.0
	$\Delta t -10^{\circ}\text{C}$	>8.0	>8.0	>8.0	>8.0	>8.0	>8.0
Noise Level NC	Top Entry	20	20	25	30	35	40

### SIZE 630/650

Volume Flow rate m <sup>3</sup> /s	0.50	0.64	0.78	0.92	1.06	1.20	
Pressure Drop (Pa)	Top Entry	10.0	17.0	26.0	37.0	50.0	64.0
Throw to 0.25m/s (m)	$\Delta t +10^{\circ}\text{C}$	2.4	3.2	3.9	4.5	5.1	5.8
	$\Delta t +5^{\circ}\text{C}$	3.4	4.3	5.2	6.0	6.9	8.0
	Isothermal	>8.0	>8.0	>8.0	>8.0	>8.0	>8.0
	$\Delta t -5^{\circ}\text{C}$	>8.0	>8.0	>8.0	>8.0	>8.0	>8.0
	$\Delta t -10^{\circ}\text{C}$	>8.0	>8.0	>8.0	>8.0	>8.0	>8.0
Throw to 0.5m/s (m)	$\Delta t +10^{\circ}\text{C}$	2.1	2.9	3.6	4.2	4.8	5.4
	$\Delta t +5^{\circ}\text{C}$	3.0	3.9	4.8	5.6	6.4	7.1
	Isothermal	7.3	7.9	>8.0	>8.0	>8.0	>8.0
	$\Delta t -5^{\circ}\text{C}$	>8.0	>8.0	>8.0	>8.0	>8.0	>8.0
	$\Delta t -10^{\circ}\text{C}$	>8.0	>8.0	>8.0	>8.0	>8.0	>8.0
Noise Level NC	Top Entry	20	30	35	40	45	50

# SERIES GRC

Circular Diffusers

## ORDERING SPECIFICATION

### Diffuser

SERIES	GRC	150	SB	DR	PPC RAL 9010 20% GLOSS (STANDARD FINISH)	15
LIST SIZE mm (DIA)						
SUPPORT BRACKETS (Optional)						
DAMPER OPTIONS (For Units Without Plenum) Rotary Damper ..... DR For Matt Black Finish On Damper Add Ref BB ie DR/BB						
FINISH (Please Specify)						
NUMBER REQUIRED						

### Plenum

TYPE REQUIRED: TCB/GRC	SEB/GRC	SEB/GRC	AT1	250	BH500	BB	DQ 300 Dia	TSO	DQ 300 Dia	15
THERMAL / ACOUSTIC INSULATION (SEB ONLY) 12mm Pyro (Standard) .....AT1 25mm Pyro .....AT2 12mm Armaflex .....AT3										
SIZE OF DIFFUSER CONNECTED TO : mm (DIA)										
BOX HEIGHT (Where different from Standard)										
MATT BLACK INTERNALS OPTION ..... BB										
PLENUM DAMPER OPTIONS (Plus Nominal Spigot Size) No Damper .....SS + Size Quadrant ..... DQ + Size Iris ..... DI + Size Cord Operated ..... DC + Size										
TWIN SPIGOT OPTION Adjacent ..... TSA Opposite ..... TSO										
TWIN SPIGOT DAMPER OPTIONS (see Damper Options)										
NUMBER REQUIRED										

### Size Range

List Sizes: 150, 250, 315, 350,  
450, 500, 550, 630 and 650mm Dia.

### Plenum Specification

0.7 Galvanised or Zintec coated mild steel plenum.  
Spigot Construction: Standard size spigots use plastic clip-in spigots. Non standard, a sealed screw-in steel spigot

### Fixing

#### Diffuser only:

For solid duct connection drill and rivet through diffuser neck. For flexible ducts order support brackets with the diffuser and fix with drop rods (by others)

#### Diffuser with Plenum:

Standard fixing for all units is external via drop rods (by others) through slotted holes on the top face of the plenum box.

### Finish

Standard: Polyester powder white Ral 9010 20% gloss.

Special: Polyester powder to stock BS or Ral colour.  
Stove enamel to any BS or RAL colour.

## GILBERTS

Head Office and Works  
GILBERTS (BLACKPOOL) LTD  
Gilair Works, Clifton Road,  
Blackpool.  
Lancashire FY4 4QT.  
Telephone: (01253) 766911  
Fax: (01253) 767941  
e-mail: sales@gilbertsblackpool.com  
Web: www.gilbertsblackpool.com

